



T-TRACTION

PULL TYPE GAS SPRINGS

2020 CATALOGUE

GASFEDERN – GAS SPRING – MOLLA A GAS



Discover
the potential

UNICERT
ISO 9001:2015



About Our Company

From Tradition
to Innovation

TGS started its industry adventure in early 70s by the producon of machining products for gas springs and various fields of industry. Our early gas spring producon steps started in 1992.

Day afer day we improved our manufacturing technologies and machinery equipments and caught world standards. In 2008 we started exporting our products to european countries and established our export company Tunatek Ltd. Co. for organizing our all export operations.

More than a quarter century of experience in gas spring producon ensures us self-confidence to provide our products all high level markets. Today we manufacture 5 different series in steel and stainless steel materials and dozens of different functions. Customers from about 50 countries and dozen of different industrial sectors rely on different kinds of gas springs made by TGS.



Quality Policy



All our products are designed, manufactured and delivered according to the most strict quality standards. Our experienced and specially trained employees monitor the adherence to our quality criteria in every phase of the production process. Tunalift gas springs are manufactured with the highest quality, environmentally friendly materials.

We are certified in accordance with DIN ISO 9001:2015. Our quality program starts with implementing strict quality controls on our purchase transactions. Permanent quality is guaranteed due to the uncompromisingly monitoring of raw materials, an aggressive testing program and a redundant quality control program throughout the production process.

TGS products are continuously tested to ensure reliability, long life and over all product safety for your highest satisfaction. Using our test and development laboratory, products and technology are constantly being improved.



INDEX

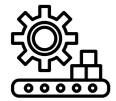

APPLICATION FIELDS [6](#)



SPRING CHARACTERISTICS [7](#)

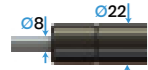

8-22 SERIES [8](#)



10-28 SERIES [10](#)



M-JOINT [12](#)

T-TRACTION SERIES



ABOUT OF T-TRACTION GAS SPRINGS

TGS T-Traction gas springs work opposite to that of a compression (general use) gas strut/springs; they retract rather than extend.

The piston is in an unloaded state inside the cylinder, and when it is loaded and pulled out, the force will attempt to pull it back into the cylinder again.

The tube is painted black and the rod has received an anti-corrosive treatment called Nitrider. However, according to your requirements we are able to offer this series with stainless steel material (SAE316).

DEMONSTRATION VIDEO



Scan for watch video on youtube



Spring Characteristics T-TRACTION SERIES

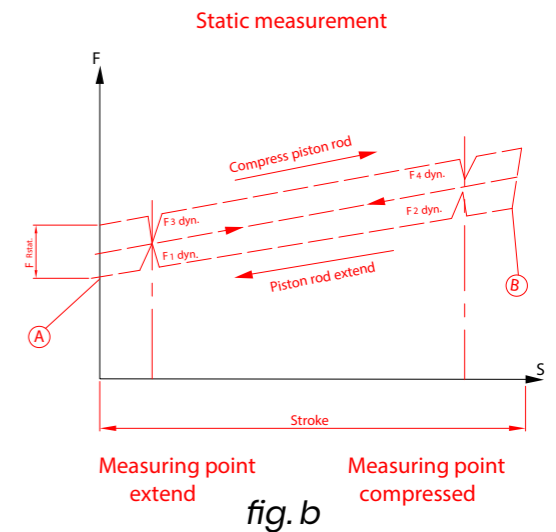
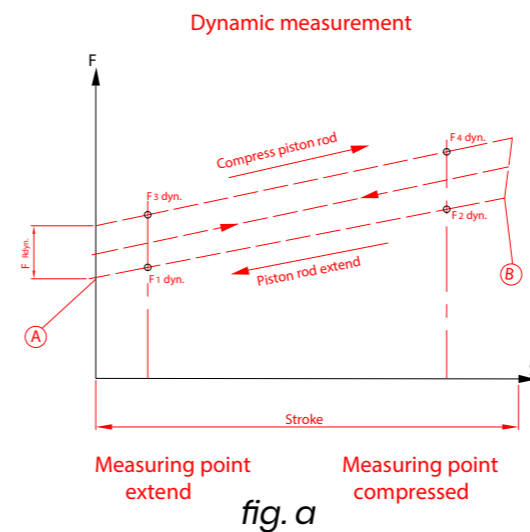
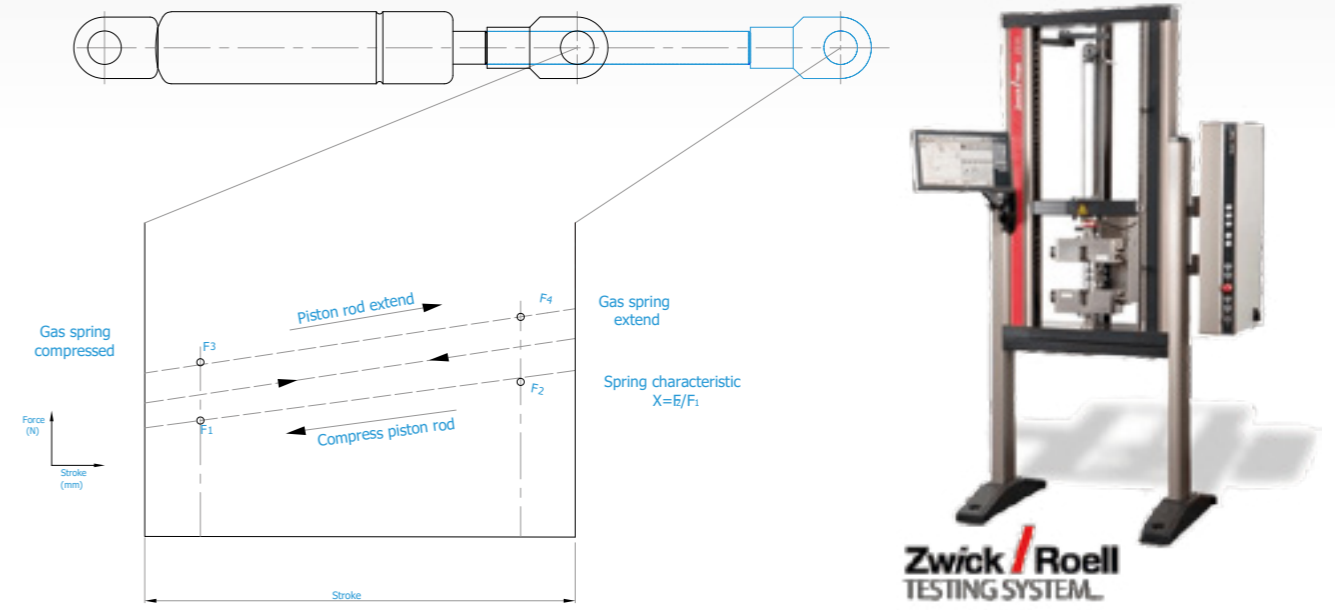

The spring characteristic curve shows the force path of the gas spring over the stroke, from the extended to the retracted state and back. The spring characteristic illustrates the balance of power of $F2/F1$. For the design of gas springs, the force $F1$ is, in addition to the dimensions, the most important criterion. The force $F1$ is measured 5mm before the end of the extension movement and thus defies the value of the spring force.

Gas Springs are being measured by two methods; Dynamic measurement and Static measurement. In Dynamic measurement (fig.a) method test equipment records the force reaction during compression/extension at the same constant velocity. The Static measurement (fig.b) is performed with a constant speed similar to the Dynamic measurement. However, test equipment interrupts the motion at the measuring points and the spring force is being measured in a static condition.

ND.100.200 - 100N - Y019 - Y019 - MJ22 - 15

REFERENCE NO

F1

ROD MOUNTING

TUBE MOUNTING

ADDITIONAL ACCESSORIES

select from list

pressure rate

optional

optional

optional



Order Example

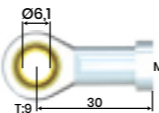
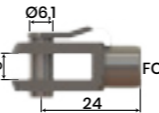
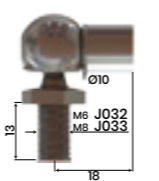
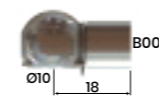
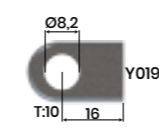
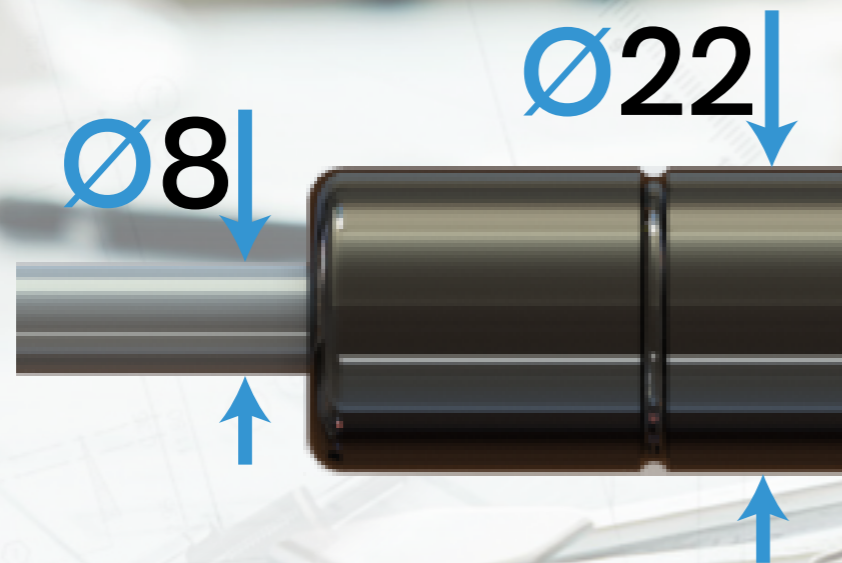

S	CL	F1	REF. NO
STROKE LENGTH	EXTENDED LENGTH	PRESSURE RATE	
20	100	100N-800N	ND.20.100
30	112	100N-800N	ND.30.112
50	132	100N-800N	ND.50.132
60	160	100N-800N	ND.60.160
80	180	100N-800N	ND.80.180
100	200	100N-800N	ND.100.200
120	220	100N-800N	ND.120.220
150	232	100N-800N	ND.150.232
160	260	100N-800N	ND.160.260
200	300	100N-800N	ND.200.300
250	349	100N-800N	ND.250.349



M-JOINT

MJ22-15 / Extends L +15mm

MJ22-25 / Extends L +25mm



M-JOINT extends length of standard item with mounting on tube end. Please check page 12 for detailed information.



OA.100.200 - 150N - Y009 - Y009 - MJ28 - 25

REFERENCE NO

F1

ROD MOUNTING

TUBE MOUNTING

ADDITIONAL ACCESSORIES

select from list

pressure rate

optional









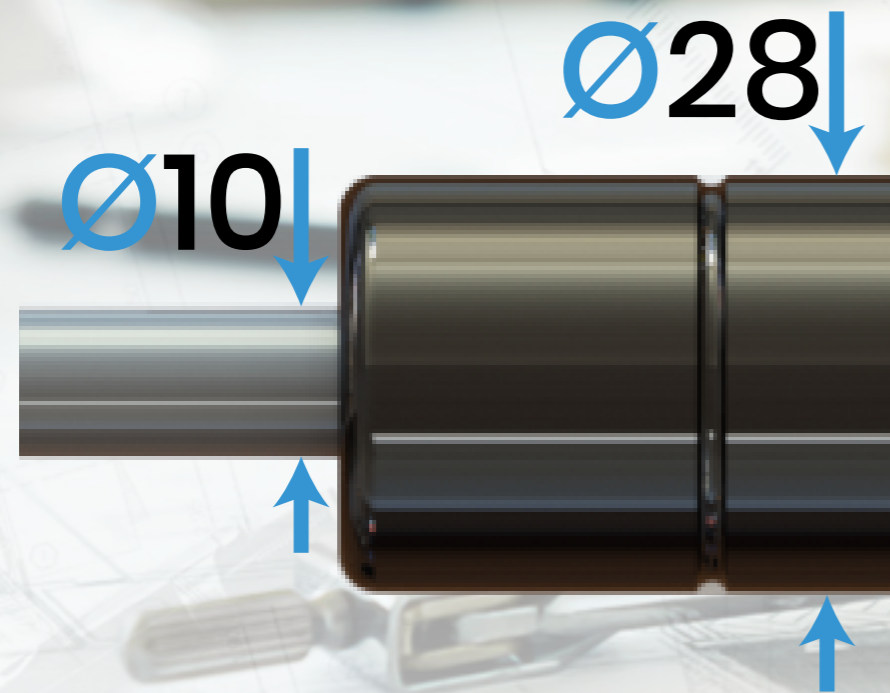

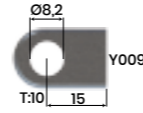
optional

optional

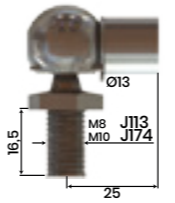

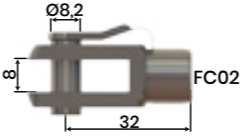
Order Example

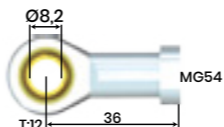

	S	CL	F1	REF. NO	
	STROKE LENGTH	EXTENDED LENGTH	PRESSURE RATE		
	30	130	150N-1200N	OA.30.130	
	50	150	150N-1200N	OA.50.150	
	100	200	150N-1200N	OA.100.200	
	150	249	150N-1200N	OA.150.249	
	200	300	150N-1200N	OA.200.300	
	250	349	150N-1200N	OA.250.349	
	300	400	150N-1200N	OA.300.400	
	350	450	150N-1200N	OA.350.450	
	400	500	150N-1200N	OA.400.500	
	450	550	150N-1200N	OA.450.550	
	500	600	150N-1200N	OA.500.600	



M-JOINT

MJ28-15 / Extends L +15mm

MJ28-25 / Extends L +25mm



M-JOINT extends length of standard item with mounting on tube end. Please check page xx for detailed information.



M-JOINT EXTENDERS FOR T-TRACTION SERIES GAS SPRINGS

M-JOINT is original gas spring length extender which designed and patented by TGS. It has monoblock steel design, which gives original tube end shape with both side connection thread (male-female) accordingly.

M-JOINT designed to give more variety to standard range T-MOTION, T-BLOCK, T-INOX, T-TRACTION and T-CLICK gas springs. This simple part will help distributors and stock keepers to keep less variety with maximum opportunity.



Scan for watch video on youtube

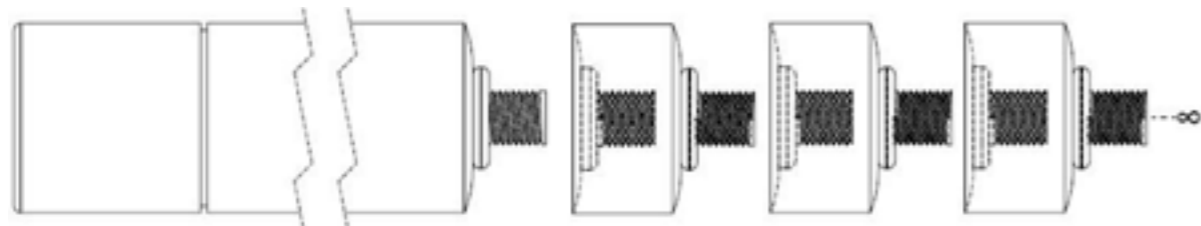

> Cluted form gives durability and resists all pressures.



T22 : 1200N
T28 : 2500N

> Tube end shape gives originally integrated part appearance.

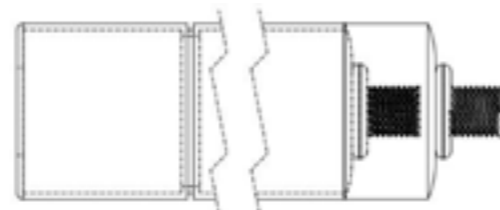

M-JOINT

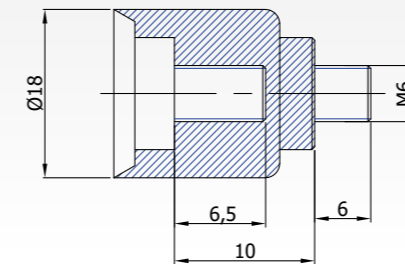

FEATURES MJ22-15

Material Information	Steel, DIN 1.0718
Surface Treatment	Zinc plated
Compatible With	T22
Unit Weight	0,009 KG

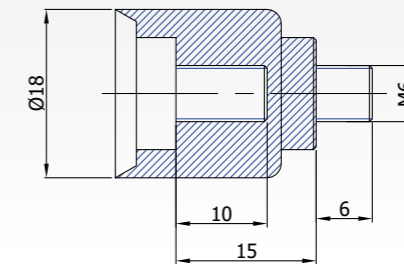

FEATURES MJ22-20

Material Information	Steel, DIN 1.0718
Surface Treatment	Zinc plated
Compatible With	T22
Unit Weight	0,009 KG

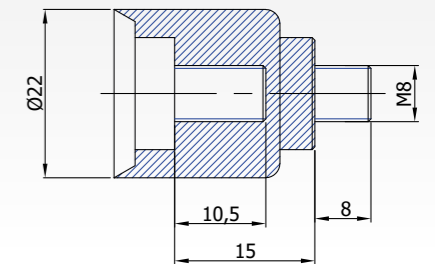

FEATURES MJ28-15

Material Information	Steel, DIN 1.0718
Surface Treatment	Zinc plated
Compatible With	T28
Unit Weight	0,009 KG

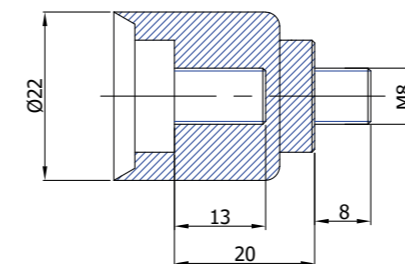

FEATURES MJ28-25

Material Information	Steel, DIN 1.0718
Surface Treatment	Zinc plated
Compatible With	T28
Unit Weight	0,009 KG



"Feel Safe!"
www.tunalift.com



Bursa, Turkey



+90 224 211 44 73



info@tunalift.com



www.tunalift.com